

Garcia ABU-MATIC 280

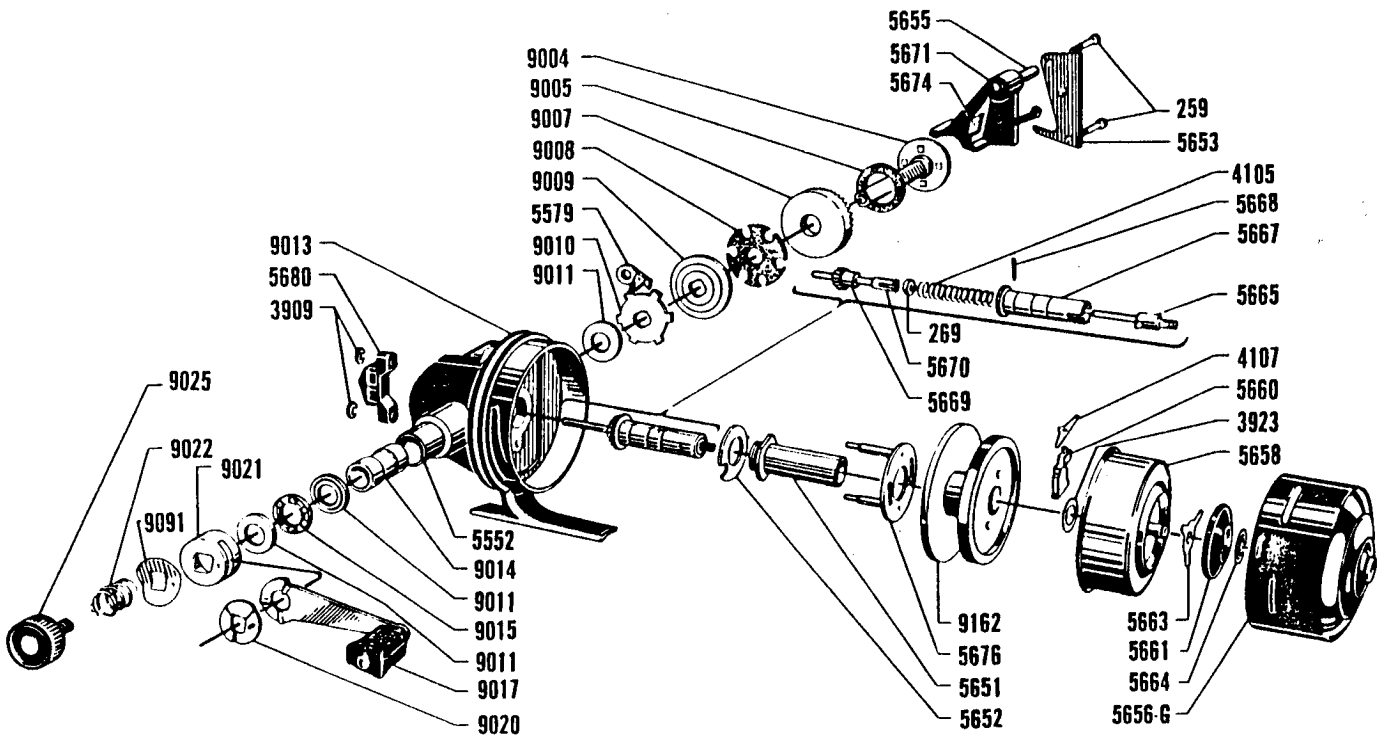

Prices subject to change without notice

Please specify both reel model and part numbers when ordering.

No.	Part Name	Price	No.	Part Name	Price	No.	Part Name	Price
259	Side Plate Screw	(each) .15	5663	Cushion Tension Spring	.10	9009	Drag Pressure Plate	1.00
269	Spool Axle Screw	.10	5664	Cushion "C" Lock	.10	9010	Anti Reverse Ratchet	.20
3909	"C" Lock	(each) .10	5665	Spool Axle	.60	9011	Ball Bearing Race and Spacer (each)	.10
3923	Winding Cup Spacer	.10	5667	Spool Axle Bearing	2.10	9013	Housing	6.25
4105	Spool Axle Spring	.10	5668	Axle Bearing Pin	.10	9014	Drive Shaft Bearing	.60
4107	Line Pick Up Spring	.10	5669	Pinion Gear	.75	9015	Ball Bearing	.75
5552	Oilite Bushing	.50	5670	Throw Out Pin	.50	9017	Handle	2.10
5579	Anti Reverse Dog	.75	5671	Line Release Trigger	.75	9020	Synchro Slide	.50
5651	Pinion Gear Bushing	2.10	5674	Release Trigger Plate	.10	9021	Dust Shield	.75
5652	Pinion Bushing Lock	.10	5676-8	Spool Mount	1.60	9022	Drag Knob Spring	.10
5653	Side Plate	.75	5680	Oscillation Guide	.25	9025	Drag Adjusting Knob	1.05
5655	Release Trigger Bushing	.10	9004	Drive Shaft with Click Plate	1.60	9091	Spring Washer	.10
5656G	Bell Cover	3.50	9005	Base Drag Washer	.10	9162	Spool, with Container	4.00
5658	Winding Cup	6.00	9007	Drive Gear with Click Spring	2.75	9228	Spool Container	.60
5660	Line Pick Up	2.10	9008	Drag Washer	.20			
5661	Rubber Cushion	.60						

PARTS AND SERVICE AVAILABLE AT THE FOLLOWING REGIONAL FACTORY REPAIR DEPOTS:

FACTORY SERVICE
RODS, REELS AND PARTS

THE GARCIA SERVICE DEPARTMENT
329 ALFRED AVENUE
TEANECK, NEW JERSEY 07666

THE CONOLON CORPORATION
1111 EAST McFADDEN STREET
SANTA ANA, CALIFORNIA 92705

SILICOTE SALES DIVISION
520 WEST 14th AVENUE
OSHKOSH, WISCONSIN 54902

J. K. CLARK COMPANY
ACO SPORTSMEN SERVICE
13501 VAN DYKE
DETROIT, MICHIGAN 48234

REEL SERVICE AND PARTS

NATE BUELL SERVICE CORPORATION
5013 N.E. 42nd STREET
PORTLAND, OREGON 97218

HARRY C. MILLER CO., INC.
257 PARK AVENUE SOUTH
NEW YORK, NEW YORK 10010

SHERMAN LOYD SALES COMPANY
4737 GREENVILLE AVENUE
DALLAS, TEXAS 75208